







































**A70-019**





**Πολυλειτουργικό Τραπέζι Παιχνιδιών 4 σε 1**

**ΠΡΟΕΙΔΟΠΟΙΗΣΗ:** Κίνδυνος πνιγμού – Μικρά μέρη. Δεν είναι κατάλληλο για παιδιά κάτω των 3 ετών. **ΠΡΟΦΥΛΑΞΕΙΣ:** Πρέπει να βεβαιωθείτε ότι το προϊόν συναρμολογείται σωστά σύμφωνα με τις οδηγίες πριν από τη χρήση. (Τα εργαλεία συναρμολόγησης περιλαμβάνονται στο κουτί) Η διαδικασία συναρμολόγησης πρέπει να γίνει από έναν ενήλικα ή υπό την επίβλεψη ενός ενήλικα.

|            |     |   |            |    |  |           |     |   |
|------------|-----|---|------------|----|--|-----------|-----|---|
| <b>P1</b>  | 2x  |    | <b>P13</b> | 1x |    | <b>T1</b> | 2x  |    |
| <b>P2</b>  | 2x  |    | <b>P14</b> | 1x |     | <b>T2</b> | 2x  |    |
| <b>P3</b>  | 1x  |    | <b>P15</b> | 1x |     | <b>T3</b> | 1x  |    |
| <b>P4</b>  | 2x  |    | <b>P16</b> | 1x |    | <b>T4</b> | 1x  |    |
| <b>P5</b>  | 2x  |    | <b>P17</b> | 1x |    | <b>S1</b> | 1x  |    |
| <b>P6</b>  | 2x  |   | <b>P18</b> | 1x |  | <b>S2</b> | 16x |   |
| <b>P7</b>  | 6x  |  | <b>P19</b> | 1x |   | <b>S3</b> | 4x  |  |
| <b>P8</b>  | 12x |  | <b>P20</b> | 1x |  | <b>S4</b> | 4x  |  |
| <b>P9</b>  | 24x |  | <b>P21</b> | 2x |  | <b>S5</b> | 6x  |  |
| <b>P10</b> | 4x  |  | <b>P22</b> | 2x |   | <b>S6</b> | 4x  |  |
| <b>P11</b> | 2x  |  | <b>P23</b> | 6x |   | <b>S7</b> | 8x  |  |
| <b>P12</b> | 2x  |  | <b>P24</b> | 6x |   | <b>S8</b> | 8x  |  |

|           |    |   |
|-----------|----|---|
| <b>Q1</b> | 2X |  |
| <b>Q2</b> | 2X |  |
| <b>Q3</b> | 1X |  |
| <b>Q4</b> | 2X |  |

|           |    |  |
|-----------|----|--|
| <b>Q5</b> | 4X |  |
| <b>Q6</b> | 2X |  |
| <b>Q7</b> | 4X |  |

|           |     |   |
|-----------|-----|---|
| <b>Z1</b> | 8X  |  |
| <b>Z2</b> | 10X |  |
| <b>Z3</b> | 6X  |  |

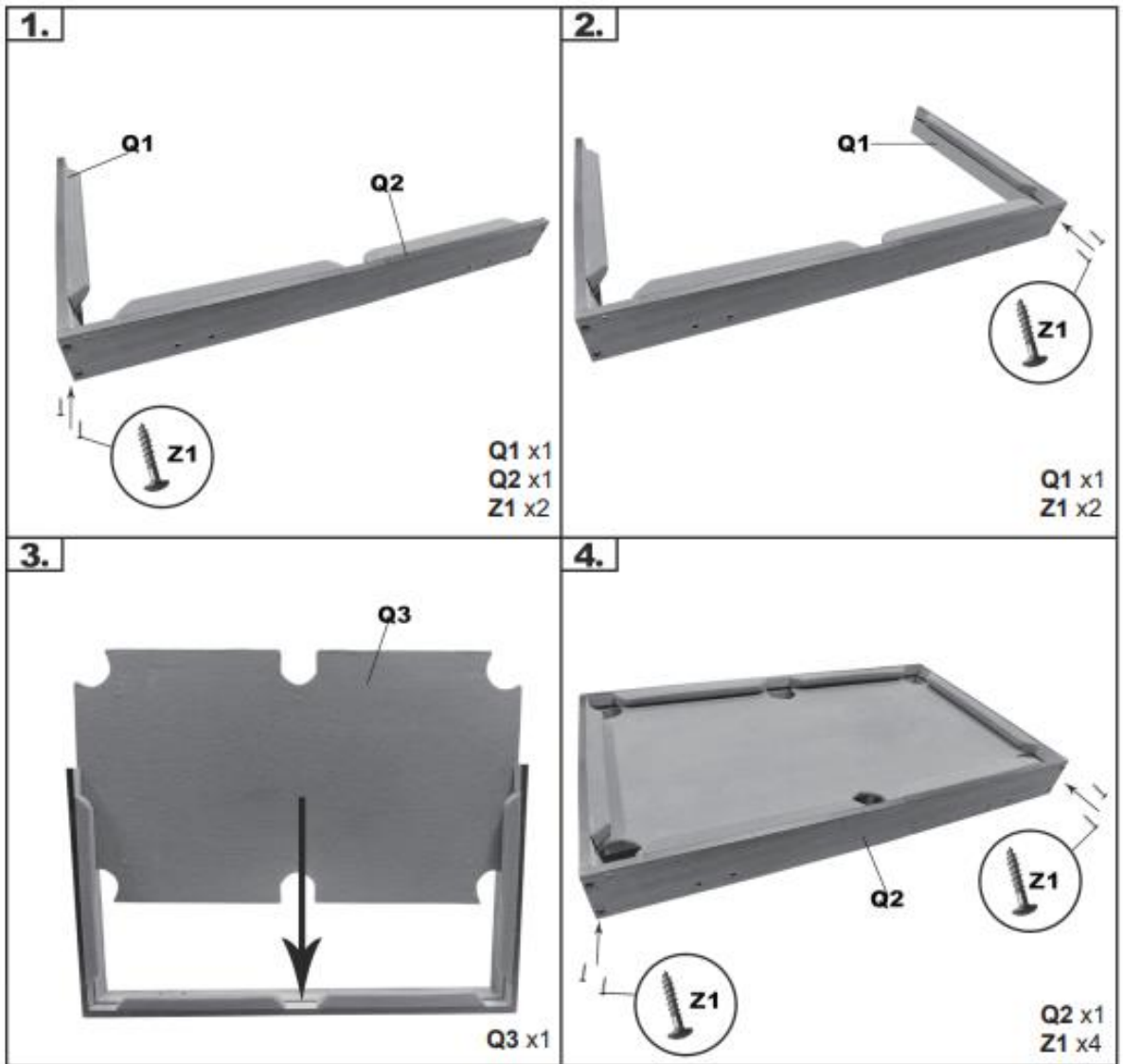

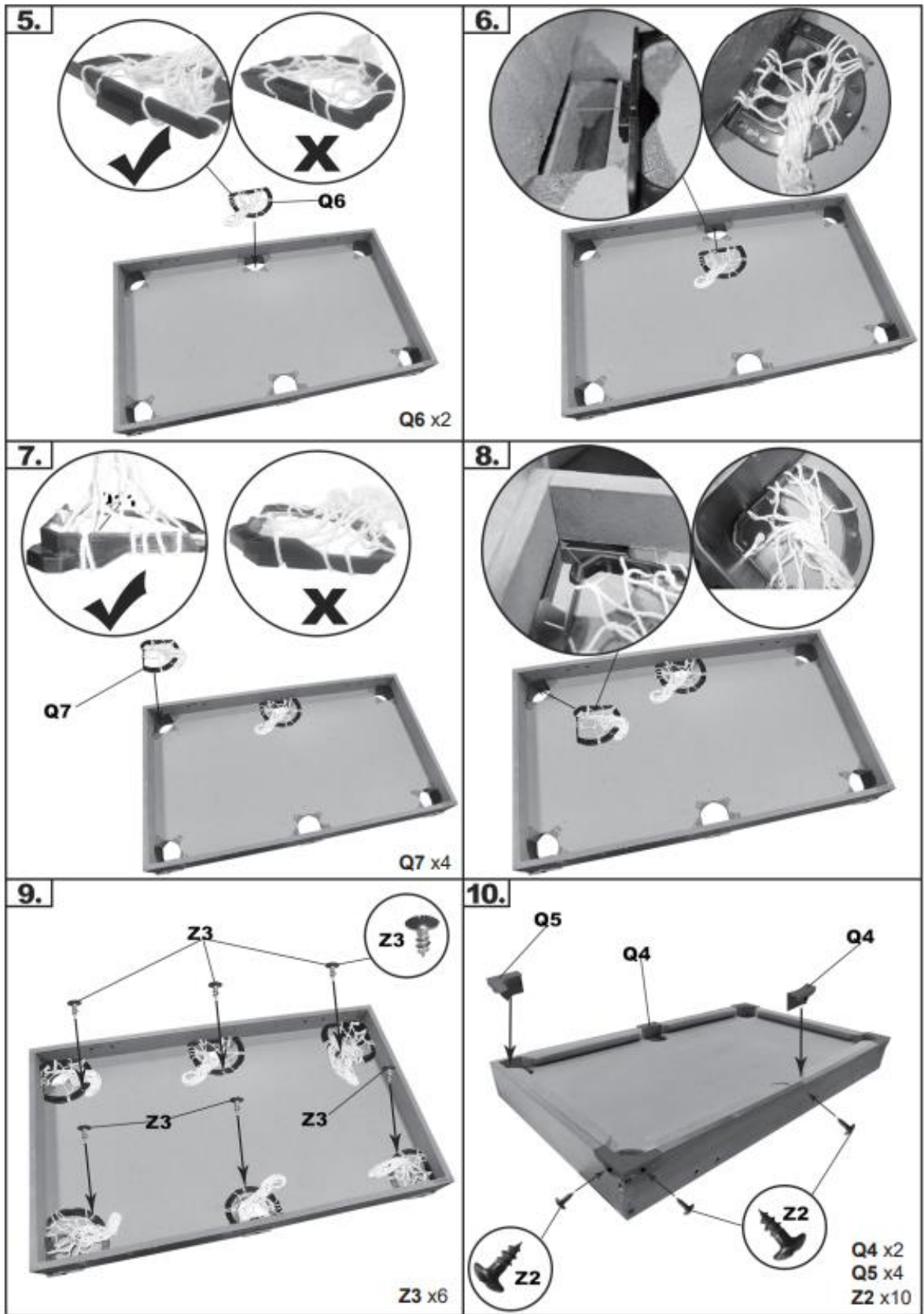

11.

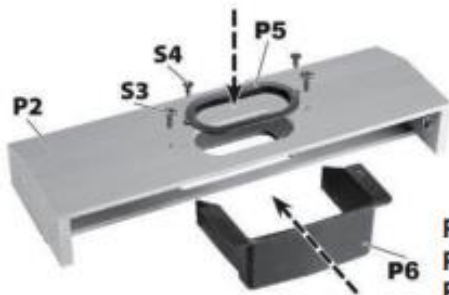

P2 x2  
 P5 x2  
 P6 x2  
 S3 x4  
 S4 x4

12.

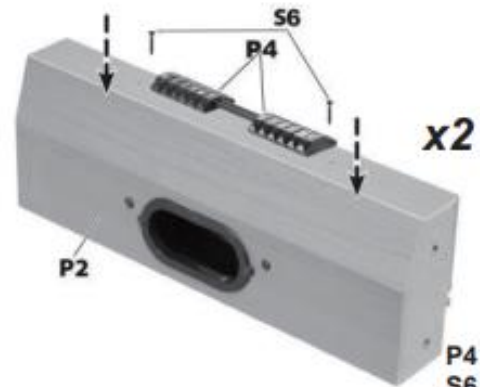

x2  
 P4 x2  
 S6 x4

13.

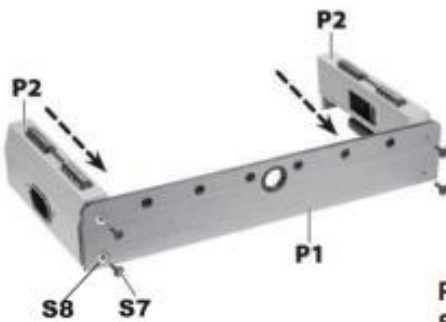

P1 x1  
 S7 x4  
 S8 x4

14.

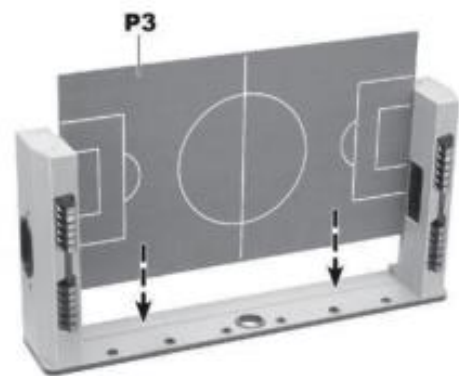

P3 x1

15.

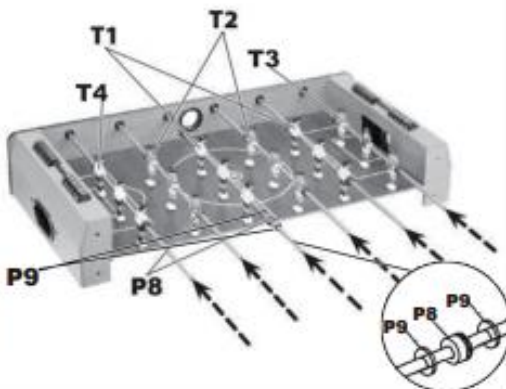

P8 x12  
 P9 x24  
 T1 x2  
 T2 x2  
 T3 x1  
 T4 x1

16.

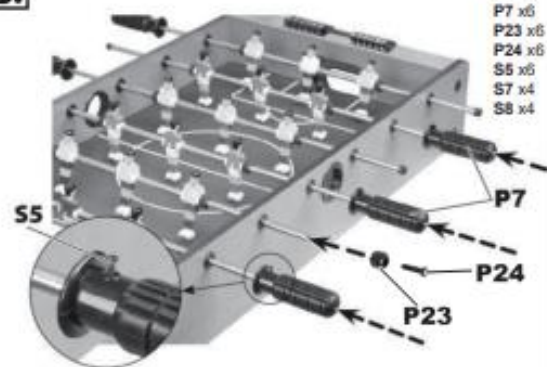

P1 x1  
 P7 x6  
 P23 x6  
 P24 x6  
 S5 x6  
 S7 x4  
 S8 x4

17.

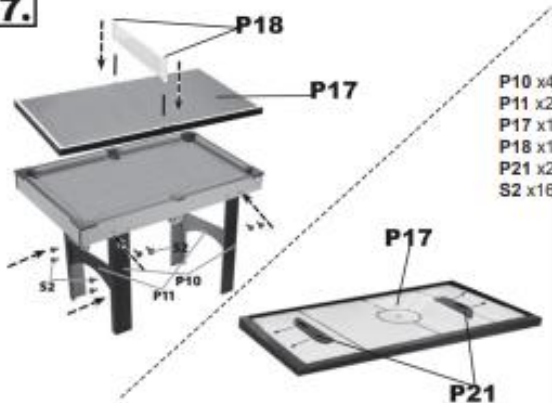

P10 x4  
 P11 x2  
 P17 x1  
 P18 x1  
 P21 x2  
 S2 x16

18.

