



845-530



**Garden Shed Εργαλειοθήκη σε ατσάλινο φύλλο
με κλειδαριά, 100x103x160cm**



ΠΡΟΕΤΟΙΜΑΣΙΑ ΣΥΝΑΡΜΟΛΟΓΗΣΗΣ

Παρακαλώ ελέγξτε τους τοπικούς οικοδομικούς κανονισμούς σχετικά με τα θεμέλια, την τοποθεσία και άλλες απαιτήσεις πριν ξεκινήσετε την κατασκευή. Μελετήστε και κατανοήστε αυτό το εγχειρίδιο με τις σημαντικές πληροφορίες και τις χρήσιμες συμβουλές για πιο εύκολη και απολαυστική συναρμολόγηση.

Οδηγίες συναρμολόγησης:

Ανασκοπώντας όλες τις οδηγίες και τις κατάλληλες πληροφορίες πριν ξεκινήσετε, βεβαιωθείτε ότι ακολουθείτε προσεκτικά την ακολουθία των βημάτων για επιτυχή αποτελέσματα.

Βάση δαπέδου:

Η τοποθεσία πρέπει να προετοιμαστεί έτσι ώστε η βάση της αποθήκης να είναι επίπεδη γύρω γύρω και να ελέγχεται με ένα πνευματικό αλφάδι. Η βάση μπορεί να κατασκευαστεί από επεξεργασμένο ξύλο ή σκυρόδεμα, για να σταματήσει η υγρασία να εισχωρεί στην αποθήκη. Η αποθήκη δεν πρέπει να χτιστεί απευθείας σε γκαζόν. Επίσης, το έδαφος θα γίνει λασπωμένο κατά τις βροχερές ημέρες. Αν γίνει βάση από σκυρόδεμα, είναι σημαντικό να γέρνει προς τις άκρες για να αποφεύγεται η είσοδος νερού. Ο χρόνος πρέπει να επιτραπεί για το στέγνωμα οποιουδήποτε σκυροδέματος ή τσιμέντου πριν τοποθετηθεί η αποθήκη πάνω σε αυτό.

Λίστα με τα μέρη:



















Πριν ξεκινήσετε, διαχωρίστε και αναγνωρίστε όλα τα μέρη και τα εξαρτήματα για να βεβαιωθείτε ότι έχετε όλα τα απαραίτητα μέρη για το κτίριό σας (ανατρέξτε στη σελίδα "Λίστα μερών").



















Η ασφάλεια πρέπει να είναι στην 1η θέση:

1. Επιλέξτε μια καθαρή και ξηρή περιοχή για τη συναρμολόγηση. Χρειάζονται δύο ή περισσότερα άτομα για την ασφάλεια κατά τη συναρμολόγηση.
2. Φορέστε προστατευτικά γάντια, μακριά μανίκια κατά τη συναρμολόγηση για να αποτρέψετε τραυματισμούς.
3. Τα παιδιά και τα κατοικίδια δεν επιτρέπονται στην περιοχή κατασκευής.
4. Να μην συγκεντρώνετε το βάρος σας στην οροφή του κτιρίου.

Φροντίδα & Συντήρηση:

1. Κρατήστε την αποθήκη καθαρή με μαλακό πανί και νερό όπου χρειάζεται.
2. Διατηρείτε τις πόρτες καθαρές από βρωμιές για να μην γλιστρούν εύκολα.
3. Καθαρίστε το χιόνι όσο πιο σύντομα γίνεται για ασφαλή πρόσβαση στην αποθήκη.

Nr. / No.		Anzahl / Quantity
1		1
2		1
3		1
4		1
P2		2
DF		1
DG		1
8		1
10		1
P4AL		1
P4		1
P4AR		1
P1AL		1
P1AR		1
P4L		1
P4R		1
UL1		1
UR1		1
9L		1

Nr. / No.		Anzahl / Quantity
9R		1
15		2
16		2
GC		4
P7		2
P8		1
DH		2
20U		1
20D		1
DLA		1
DRA		1
DX1		2
HARDWARE		
F1		106
V2		90
F2		14
F3		16
S1		90
		1

01

Telle / Parts	Nr. / No.	Stk. / Qty.
	1	1
	2	1
	4	1
	F1	4
	V2	4

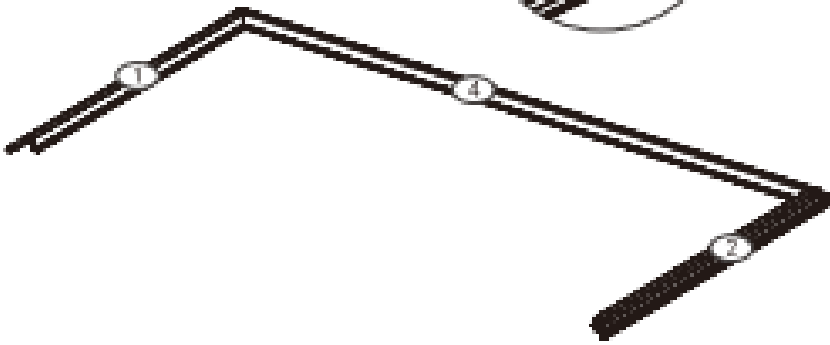
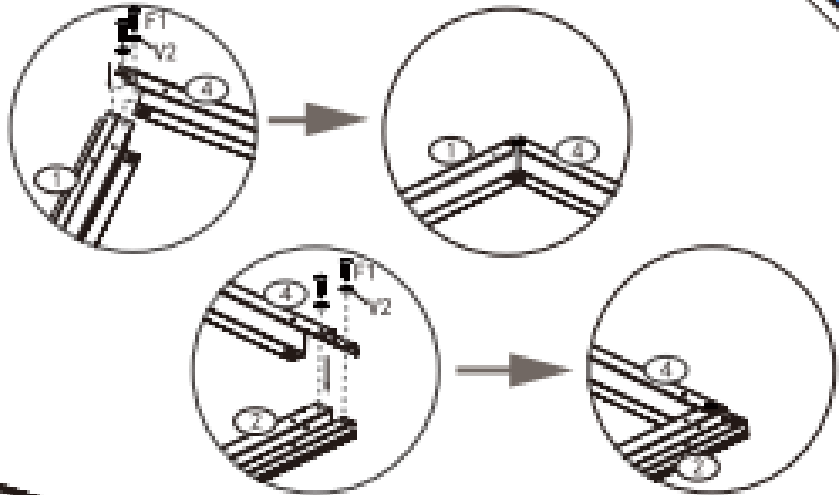
**02**



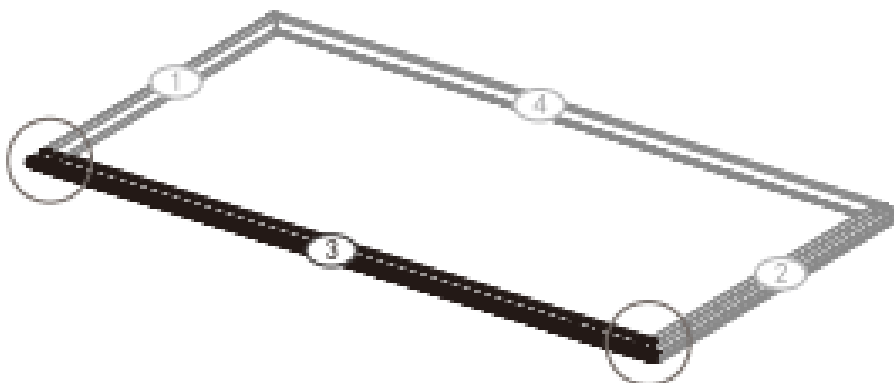
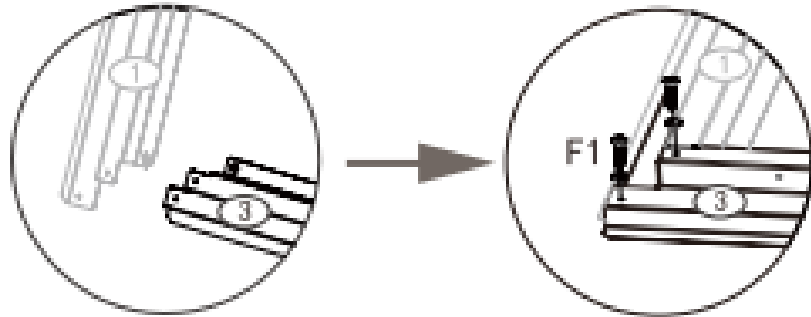

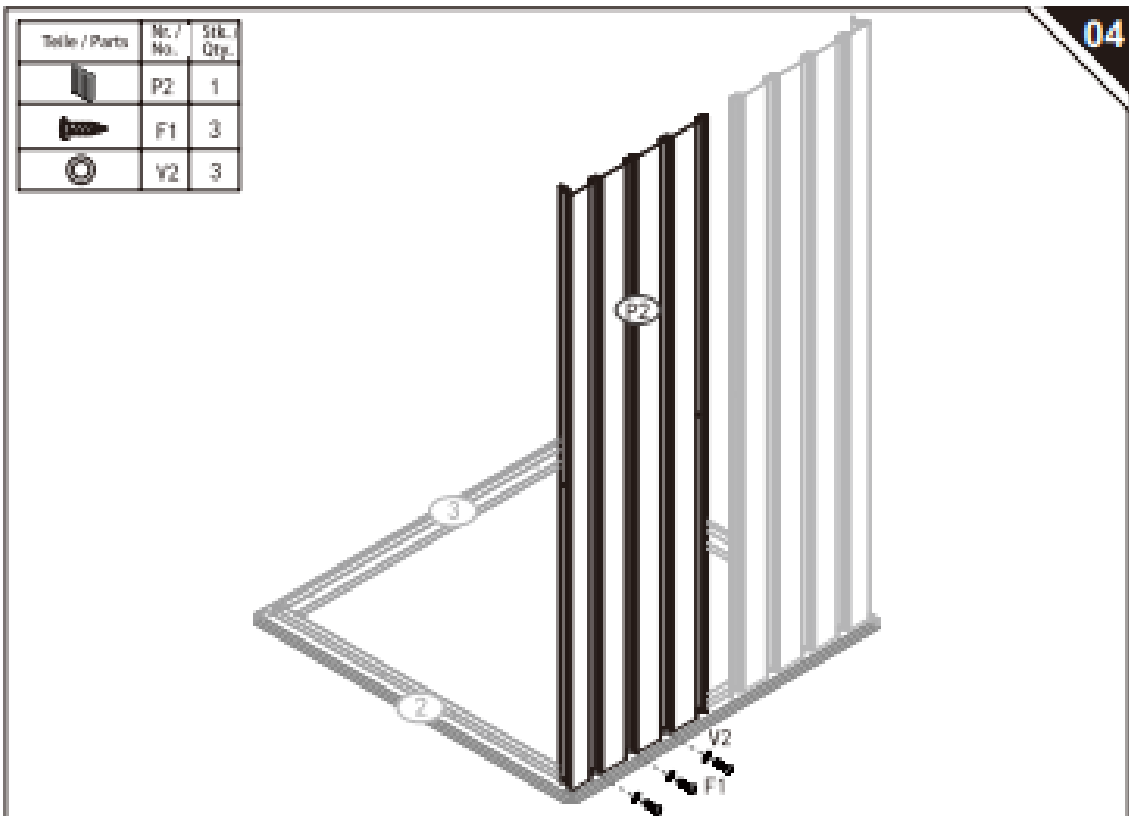
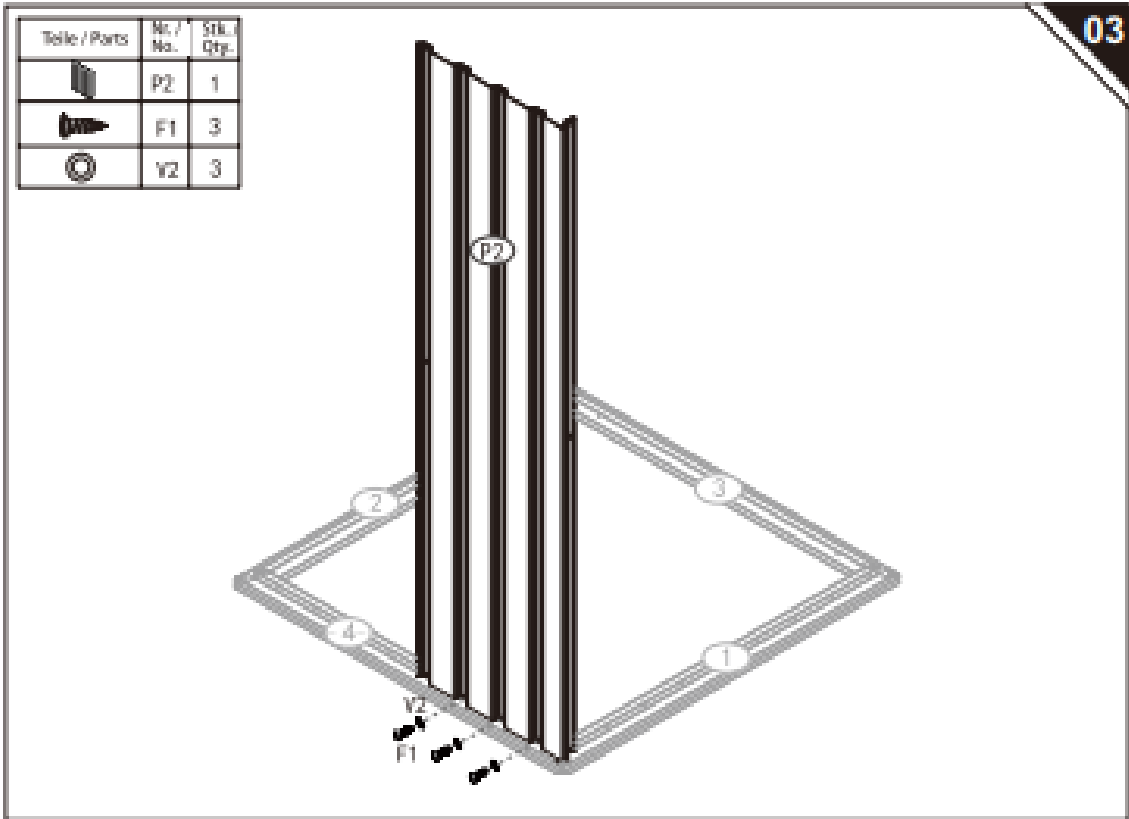
Telle / Parts	Nr. / No.	Stk. / Qty.
	3	1
	F1	4
	V2	4



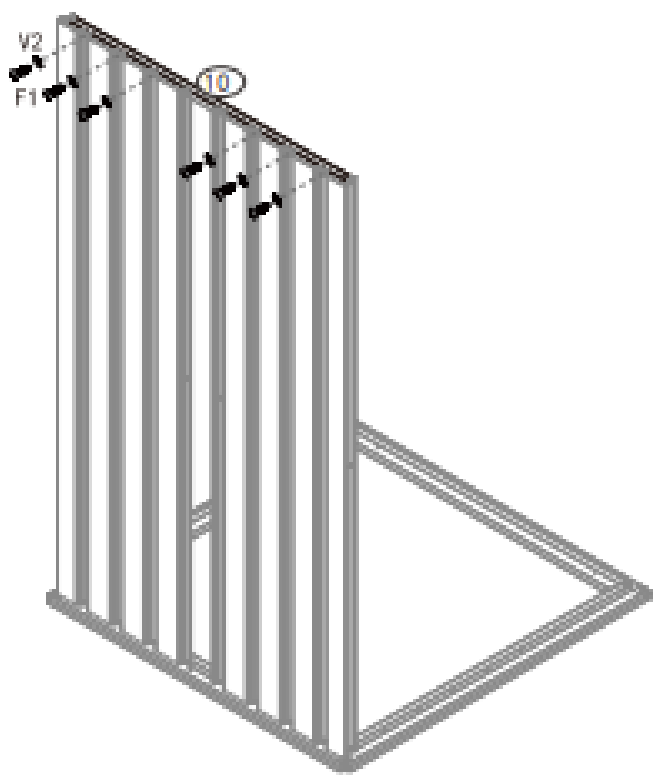

Telle / Parts	Nr. / No.	Stk. / Qty.
	10	1
	F1	6
	V2	6





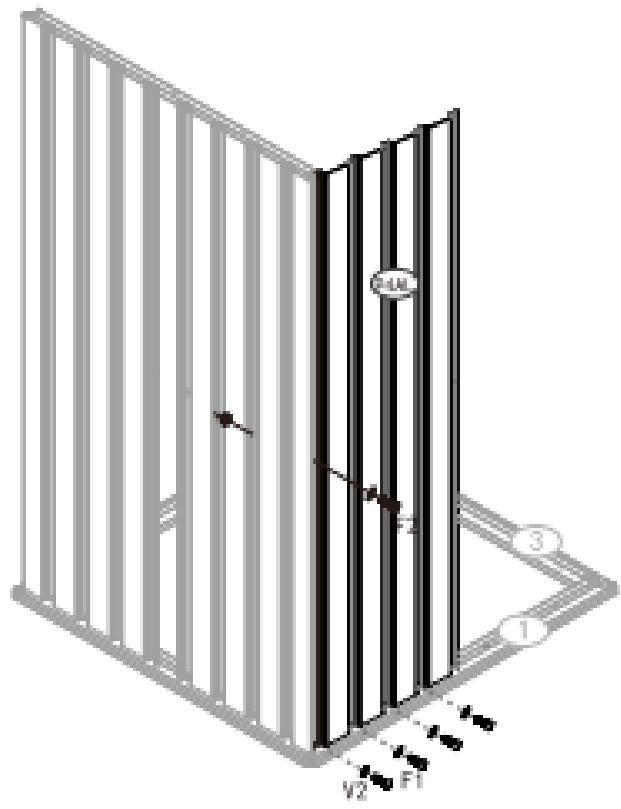

Telle / Parts	Nr. / No.	Stk. / Qty.
	F4M	1
	F1	4
	F2	1
	V2	4

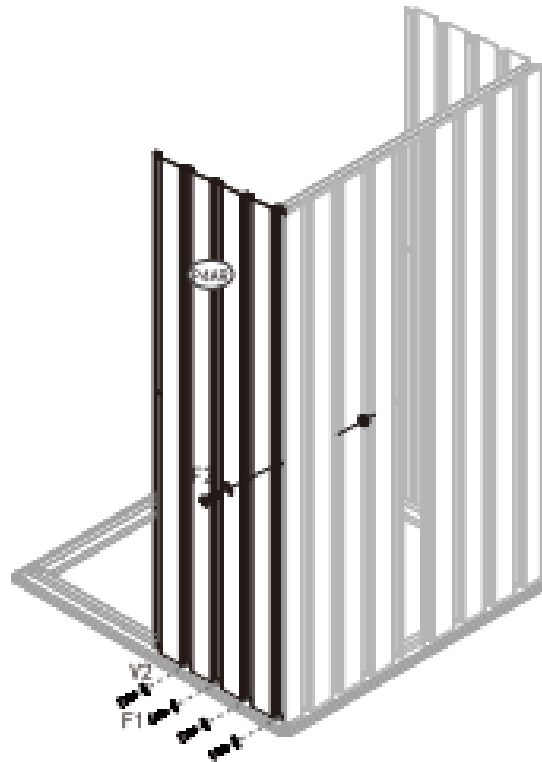

Telle / Parts	Nr. / No.	Stk. / Qty.
	P4M1	1
	F1	4
	F2	1
	V2	4



Telle / Parts	Nr. / No.	Stk. / Qty.
	P4	1
	F1	4
	V2	4
	F2	2

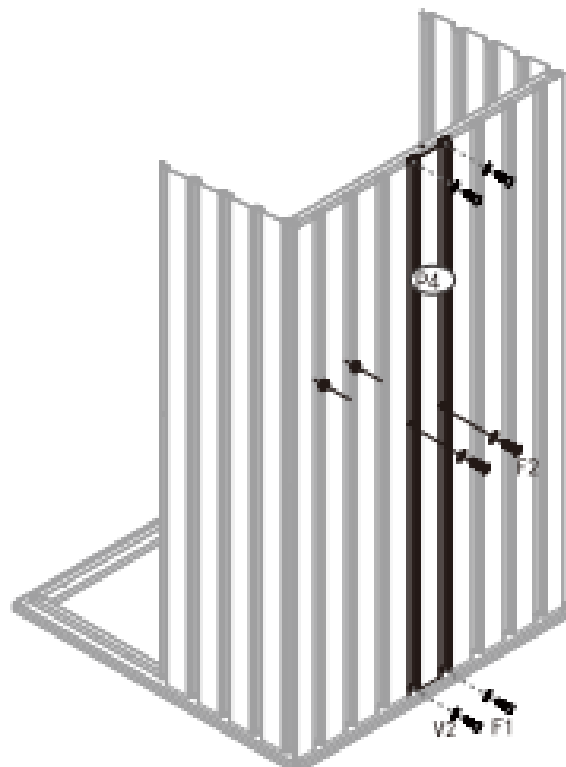

Teil / Parts	Nr. / No.	Stk. / Qty.
	P1AL	1
	F1	4
	F2	1
	V2	4

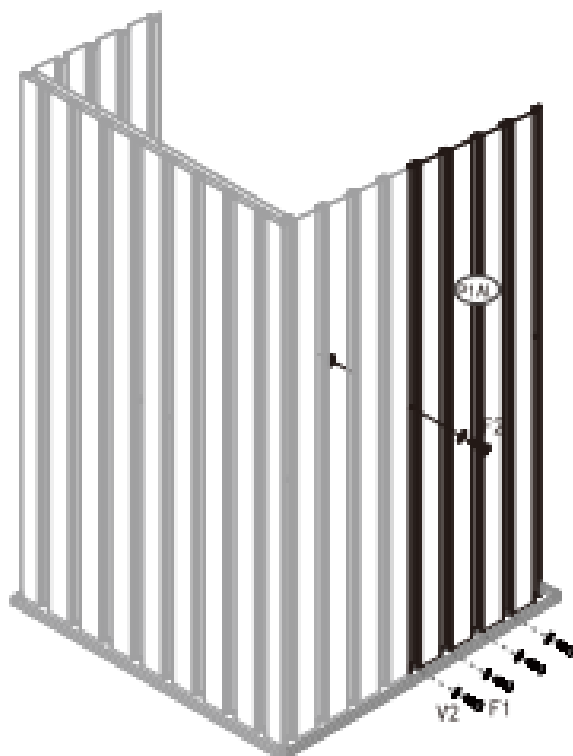

Teil / Parts	Nr. / No.	Stk. / Qty.
	P1AR	1
	F1	4
	F2	1
	V2	4

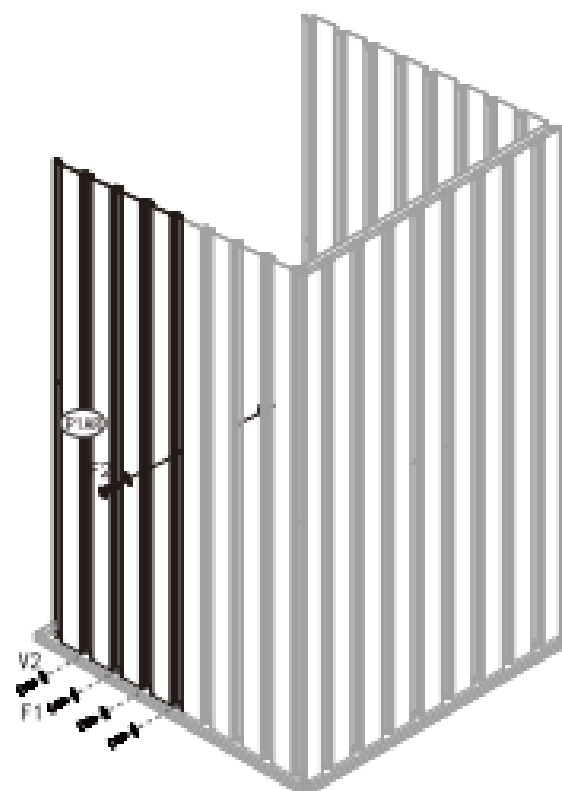

Teil / Parts	Nr. / No.	Stk. / Qty.
	14L	1
	F1	1
	F2	1
	V2	1

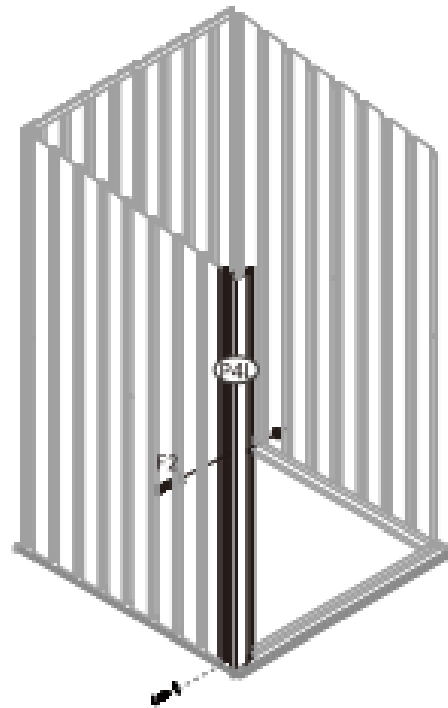



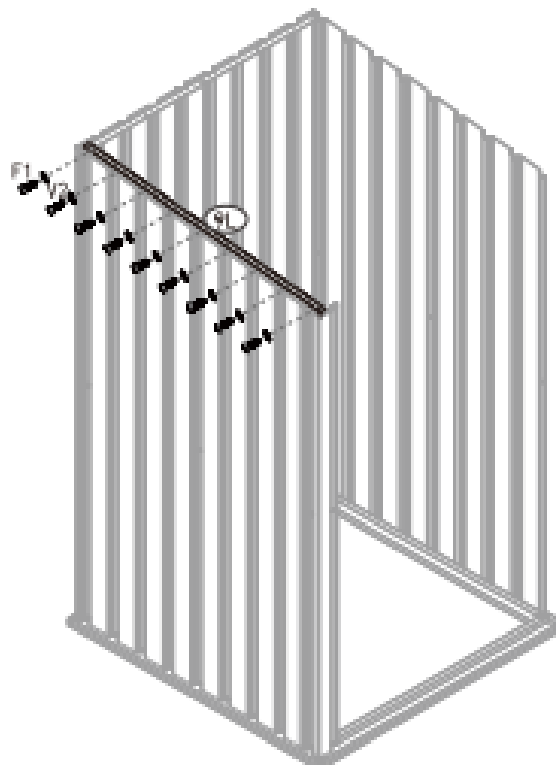

Teil / Parts	Nr. / No.	Stk. / Qty.
	9L	1
	F1	9
	V2	9

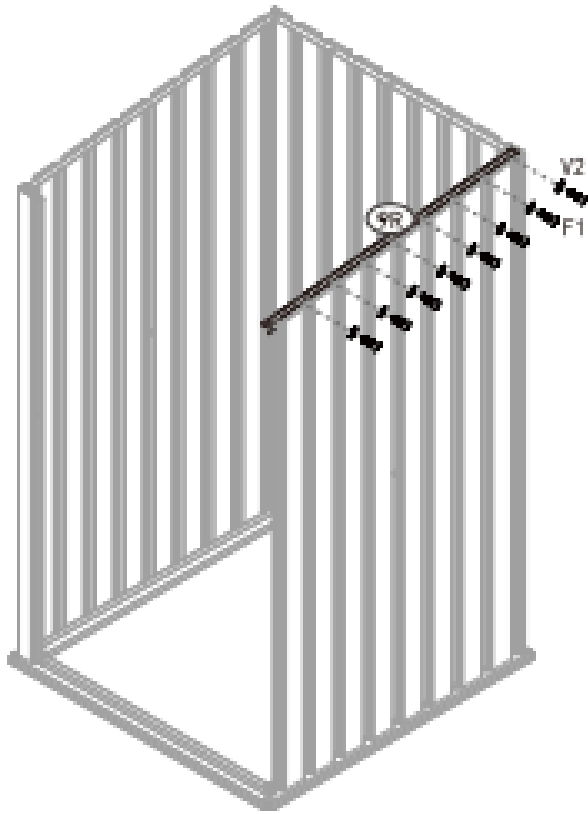

Teile / Parts	Nr. / No.	Stk. / Qty.
	WR	1
	F1	8
	V2	8



Teile / Parts	Nr. / No.	Stk. / Qty.
	P4R	1
	F1	2
	F2	1
	V2	1

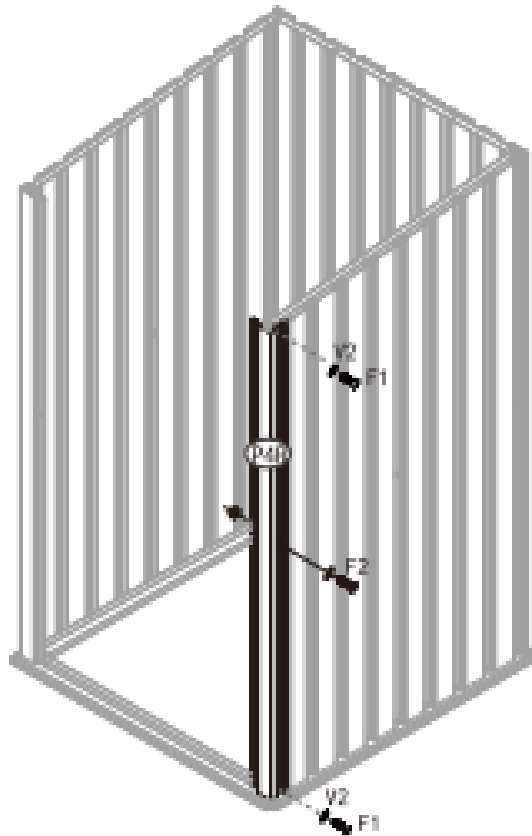

Teil / Parts	Nr. / No.	Stk. / Qty.
	UR1	1
	UL1	1
	F1	4
	Y2	4

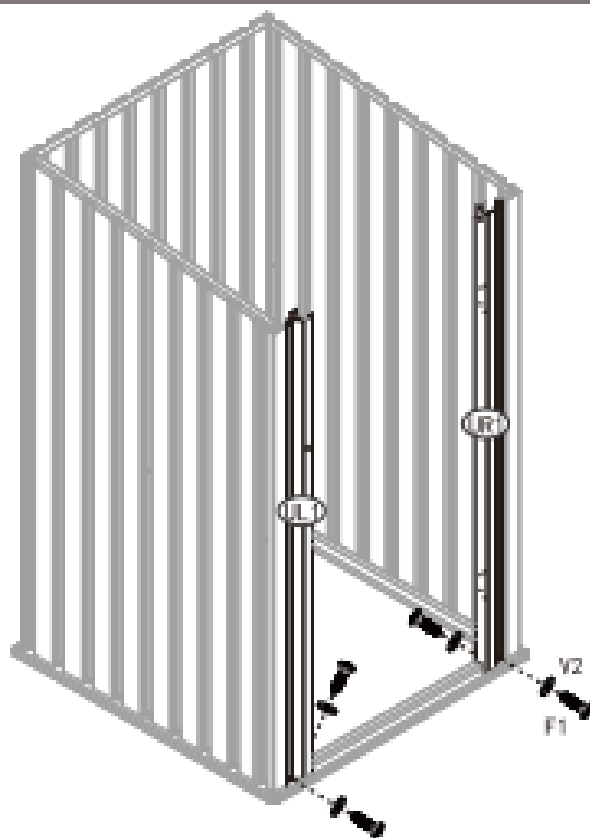

UL1 and UR1 There are holes on the inside and outside. All need to be fixed with screws

Teil / Parts	Nr. / No.	Stk. / Qty.
	B	1
	F1	4
	Y2	4

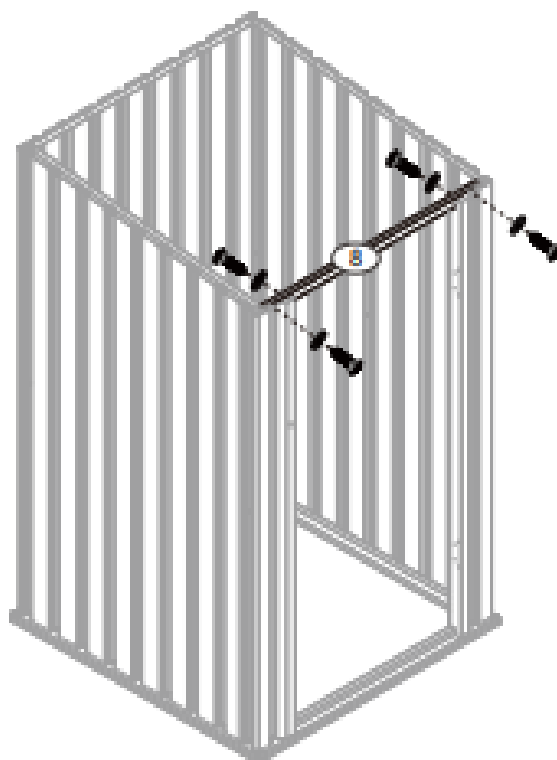

Table / Parts	No. / No.	Stk. / Qty.
	P7	2
	F1	8
	V2	8

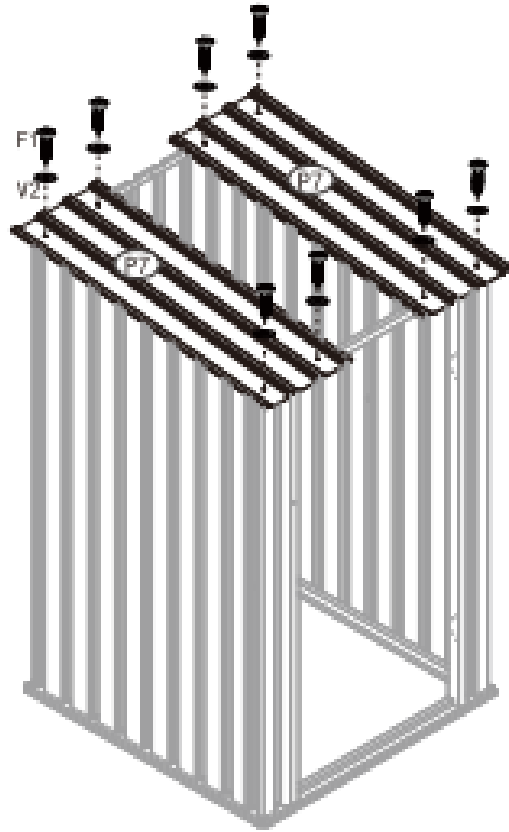
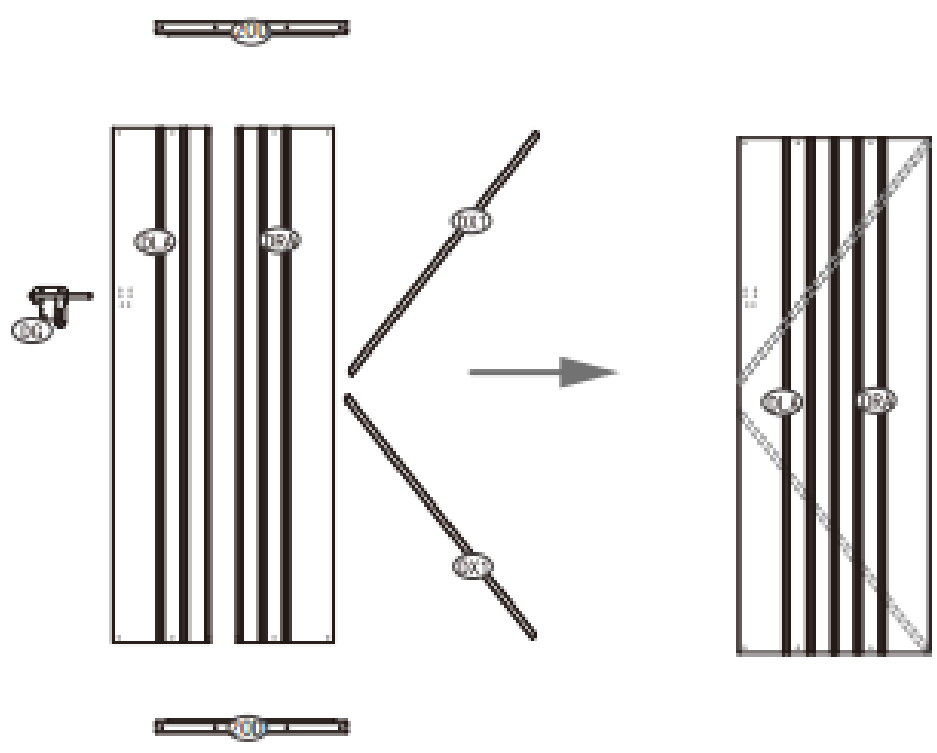
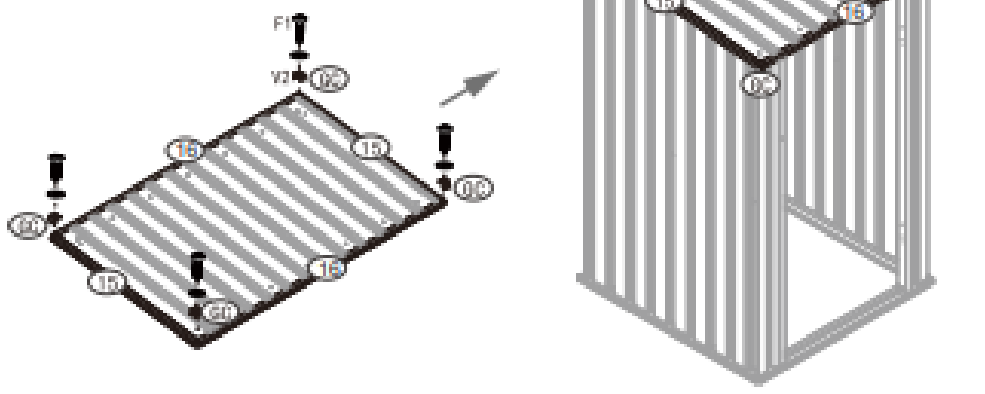
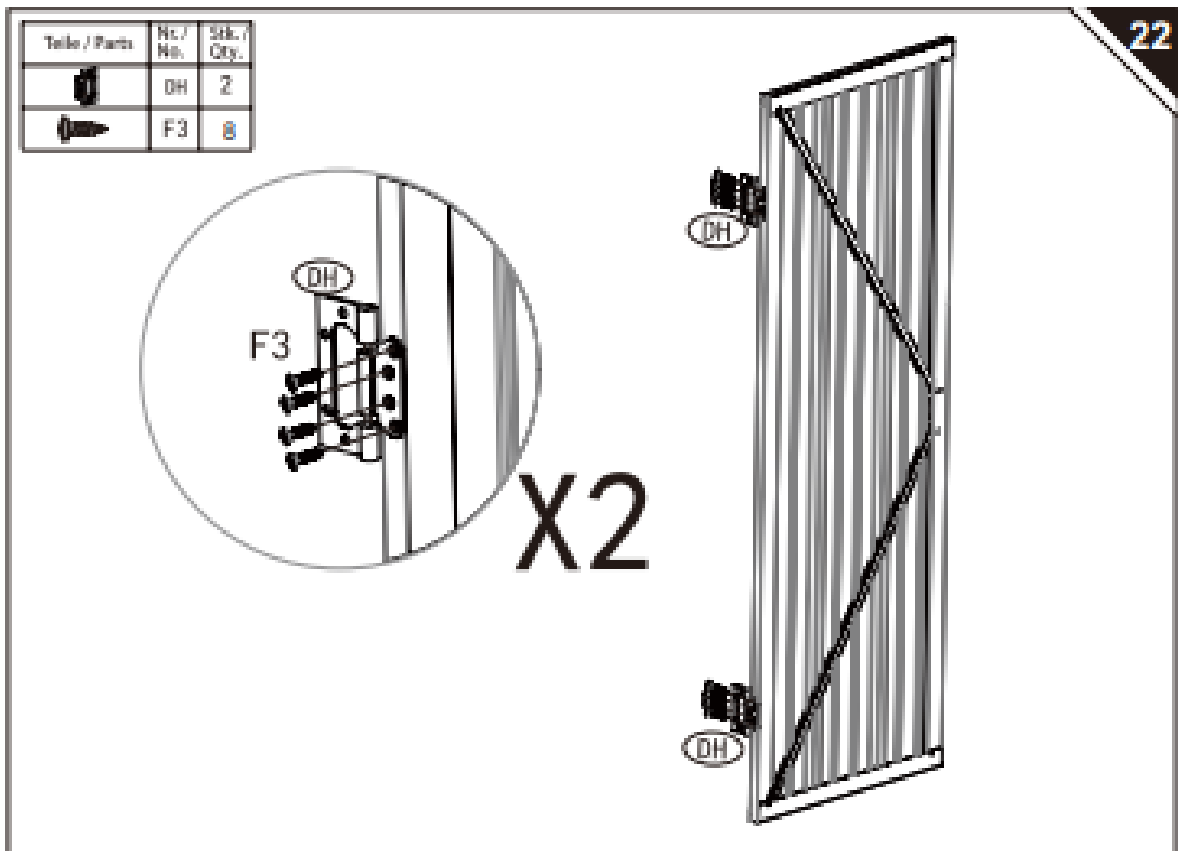
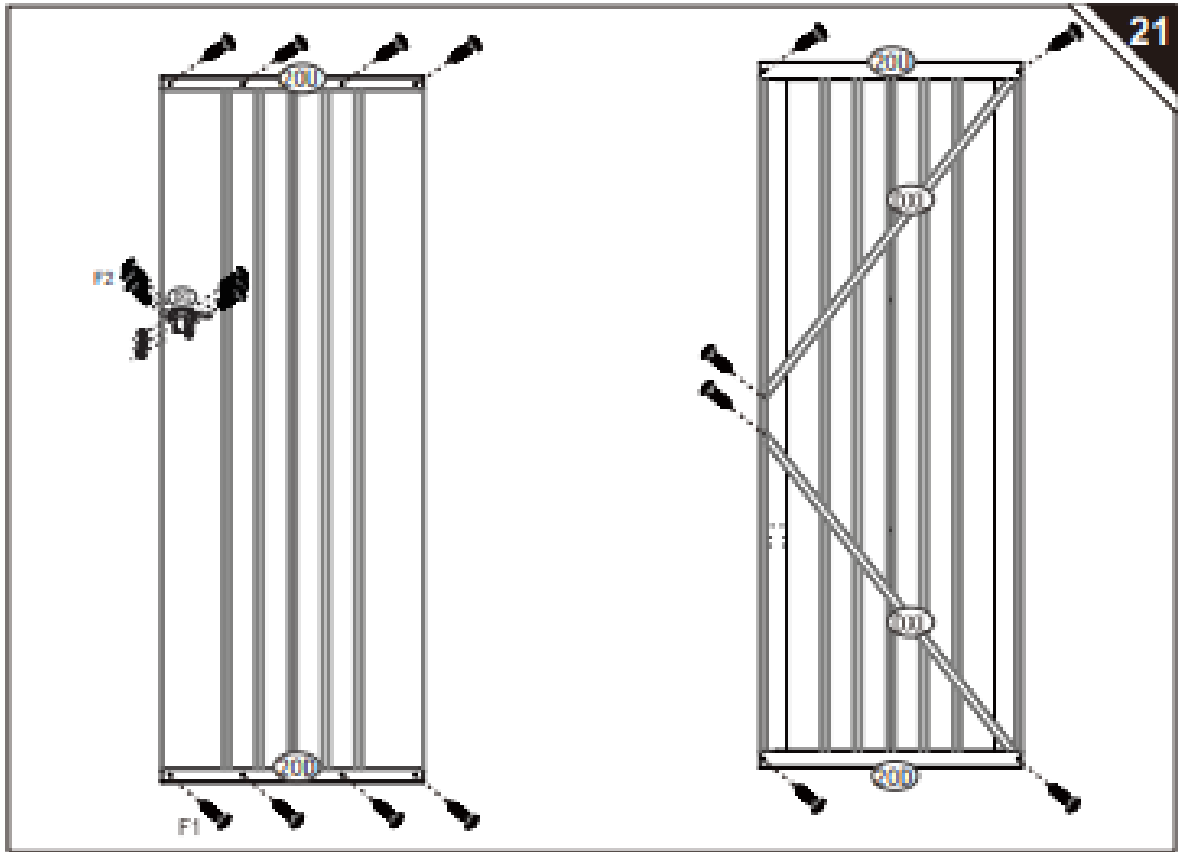

Table / Parts	No. / No.	Stk. / Qty.
	P8	1
	F1	2
	V2	2



Teile / Parts	Nr. / No.	Stk. / Qty.
	15	2
	18	2
	00	4
	F1	4
	Y2	4





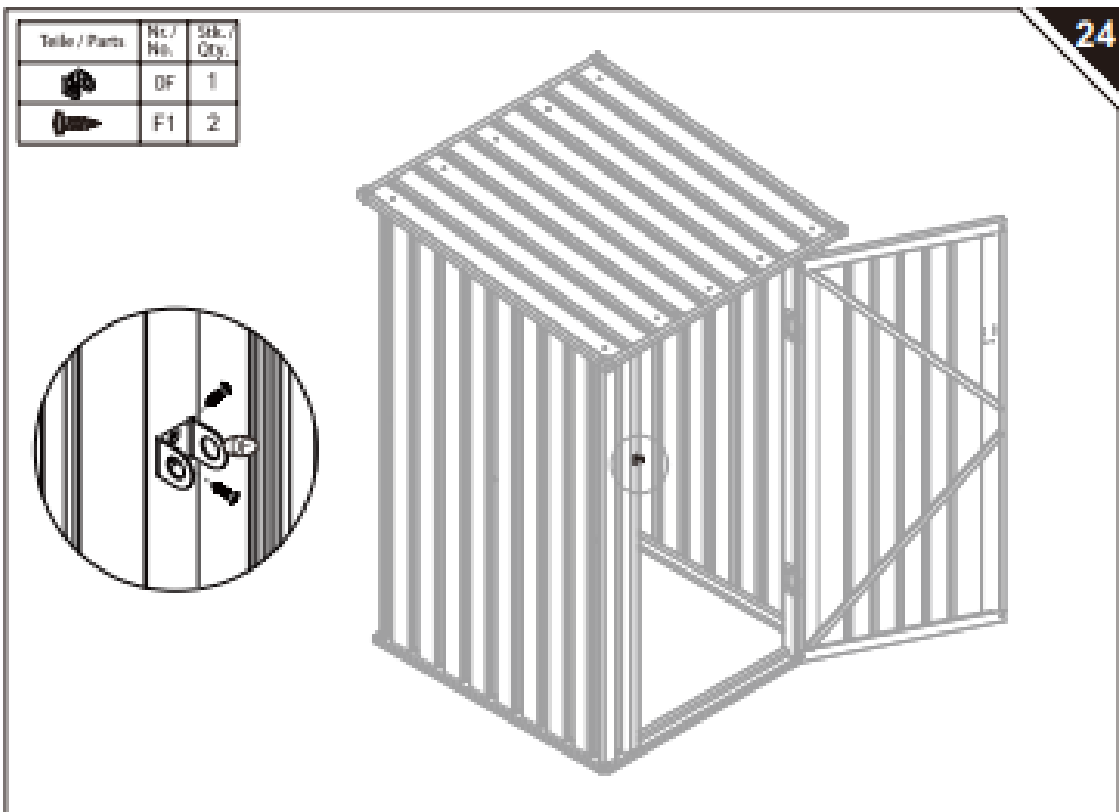
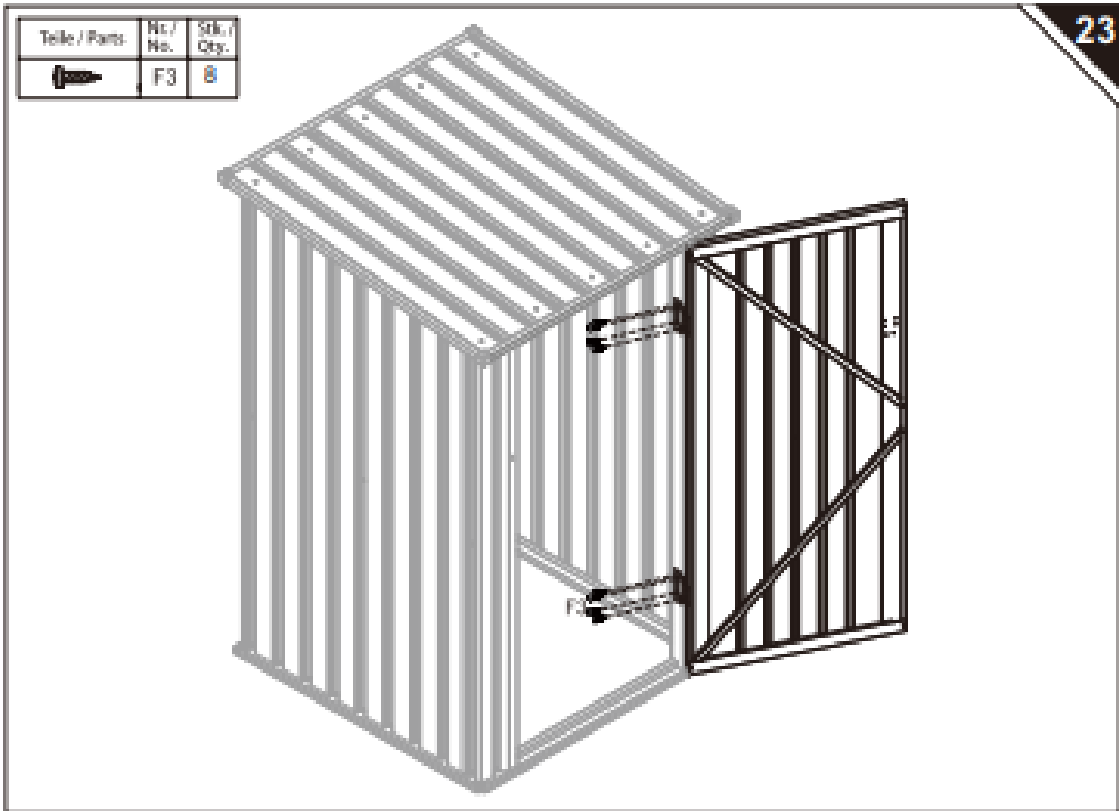

Teil / Part	Nr. / No.	Stk. / Qty.
CD	S1	90

25

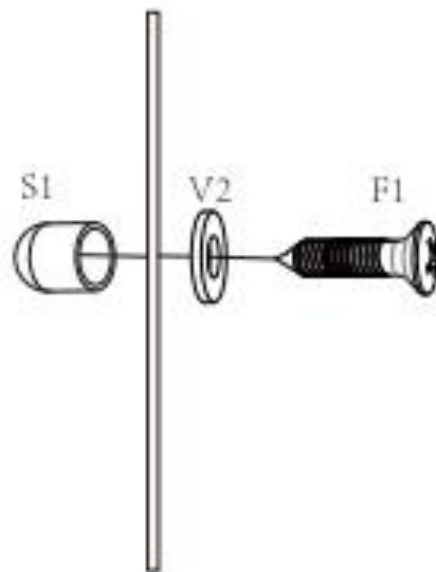

Done

