

















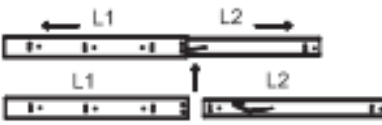

**837-003**



**Ξύλινο Ντουλάπι με 3 Πόρτες και 2  
Συρτάρια 106 x 35 x 76 cm**

NO.	QTY.	LINEDRAWING	DESCRIPTION
(A)	18		
(B)	18		
(C)	52	 Ø3.5*14	
(D)	8	 Ø3.5*35	
(E)	4		
(F)	6	 Ø7*50	
(G)	5		
(H)	10		
(I)	6		
(J)	30		
(K)	5		
(L)	4		
(M)	4		
(N)	2		
		  	<p>Hammer and Screwdriver are not included !!</p>

# PARTS LIST

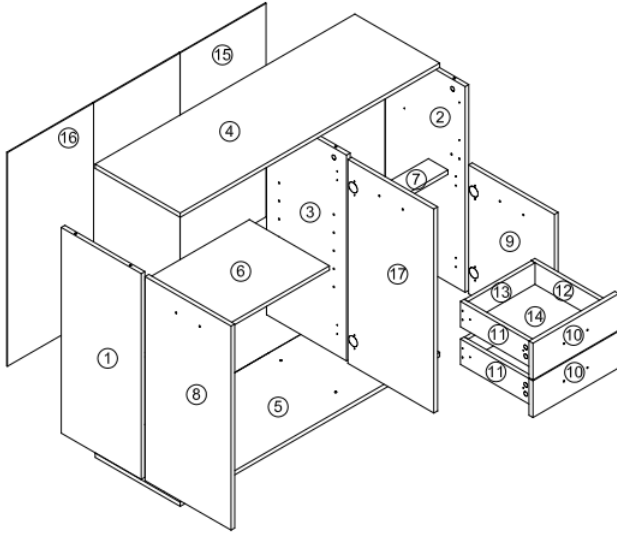

NO.	QTY.	LINEDRAWING	DESCRIPTION
①	1		
②	1		
③	1		
④	1		
⑤	1		
⑥	1		
⑦	1		
⑧	1		
⑨	1		
⑩	2		
⑪	2		
⑫	2		
⑬	2		
⑭	2		
⑮	1		
⑯	1		
⑰	1		

2 OF 4

**1**

(A) 4 PCS (B) 4 PCS

**2**

(A) 6 PCS (B) 6 PCS (F) 6 PCS

**3**

(J) 6 PCS (K) 30 PCS (I) 6 PCS

**4**

(L) 4 PCS (C) 8 PCS Ø3.5"14 (E) 4 PCS

3 OF 4

